



ELECTRONICS

Product Information

Customer : General

DATE : 27.Feb.2007

SAMSUNG TFT-LCD**MODEL : LTA320WT-L05**Any Modification of Specification is not allowed without SEC's Permission.

NOTE :

| | | | |
|----------------------------|------|---------------------|-------------|
| Customer's Approval | | APPROVAED BY | DATE |
| | | <i>Kyungheon Ko</i> | 27.Feb.2007 |
| SIGNATURE | DATE | PREPARED BY | DATE |
| | | Jin Su Jung | 27.Feb.2007 |

LCD Business

Samsung Electronics Co . , LTD.

Contents

| | |
|--|------|
| Revision History | (3) |
| General Description | (4) |
| General Information | (4) |
| 1. Absolute Maximum Ratings | (5) |
| 2. Optical Characteristics | (7) |
| 3. Electrical Characteristics | (10) |
| 3.1 TFT LCD Module | |
| 3.2 Back Light Unit | |
| 3.3 Inverter Input & Specification | |
| 4. Block Diagram | (13) |
| 5. Input Terminal Pin Assignment | (14) |
| 5.1 Input Signal & Power | |
| 5.2 Inverter Input Pin Configuration | |
| 5.3 Inverter Input Power Sequence | |
| 5.4 LVDS Interface | |
| 5.5 Input Signals, Basic Display Colors and Gray Scale of Each Color | |
| 6. Interface Timing | (19) |
| 6.1 Timing Parameters (DE only mode) | |
| 6.2 Timing Diagrams of interface Signal (DE only mode) | |
| 6.3 Power ON/OFF Sequence | |
| 7. Outline Dimension | (22) |
| 8. Packing | (24) |
| 9. Marking & Others | (25) |
| 10. General Precaution | (26) |
| 10.1 Handling | |
| 10.2 Storage | |
| 10.3 Operation | |
| 10.4 Operation Condition Guide | |
| 10.5 Others | |

Revision History

| Date | Rev. No | Page | Summary |
|--------------|---------|------|------------------|
| Feb 2, 2007 | 05.000 | all | First issued |
| Feb 27, 2007 | 06.000 | all | Version revision |

| | | | | | |
|-------|--------------|---------|-----------------|------|--------|
| MODEL | LTA320WT-L05 | Doc. No | 06-000-G-070227 | Page | 3 / 28 |
|-------|--------------|---------|-----------------|------|--------|

General Description

Description

LTA320WT-L05 is a color active matrix liquid crystal display (LCD) that uses amorphous silicon TFT (Thin Film Transistor) as switching components. This model is composed of a TFT LCD panel, a driver circuit and a back light unit. The resolution of a 32.0" is 1366 x 768 and this model can display up to 16.7 million colors with wide viewing angle of 89° or higher in all directions. This panel is intended to support applications to provide an excellent performance for Flat Panel Display such as Home-alone Multimedia TFT-LCD TV and High Definition TV.

Features

- RoHS compliance (Pb-free)
- High contrast & aperture ratio with wide color gamut
- SPVA (Super Patterned Vertical Align) mode
- Wide viewing angle ($\pm 178^\circ$)
- High speed response
- HD resolution (16:9)
- Low Power consumption
- Direct Type 12 CCFLs (Cold Cathode Fluorescent Lamp)
- DE (Data Enable) mode
- LVDS (Low Voltage Differential Signaling) interface (1pixel/clock)

General Information

| Items | Specification | Unit | Note |
|---------------------|---|-------------------|---------|
| Module Size | 760.0(H _{TYP}) x 450.0(V _{TYP}) | mm | ± 1.0mm |
| | 48.0(D _{MAX}) | | |
| Weight | 7,500 (max) | g | |
| Pixel Pitch | 0.51075(H) x 0.51075(W) | mm | |
| Active Display Area | 697.6845(H) x 392.256(V) | mm | |
| Surface Treatment | Haze 44% , Hard-coating (3H) | - | |
| Display Colors | 8 bit - 16.7M | colors | |
| Number of Pixels | 1366 x 768 | pixel | |
| Pixel Arrangement | RGB vertical stripe | - | |
| Display Mode | Normally Black | - | |
| Luminance of White | 500 (Typ.) | cd/m ² | |

MODEL

LTA320WT-L05

Doc. No

06-000-G-070227

Page

4 / 28

1. Absolute Maximum Ratings

If the condition exceeds maximum ratings, it can cause malfunction or unrecoverable damage to the device.

| Item | Symbol | Min. | Max. | Unit | Note |
|---------------------------------------|---------------|-----------|------|------|---------|
| Power Supply Voltage | V_{DD} | GND-0.5 | 5.5 | V | (1) |
| Storage temperature | T_{STG} | -20 | 60 | | (2) |
| Glass surface temperature (Operation) | Center | T_{OPR} | 0 | 50 | (2),(5) |
| | T. Uniformity | T | - | 10 | |
| Shock (non - operating) | S_{nop} | - | 50 | G | (3) |
| Vibration (non - operating) | V_{nop} | - | 1.5 | G | (4) |

Note (1) $T_a = 25 \pm 2 \text{ }^\circ\text{C}$

(2) Temperature and relative humidity range are shown in the figure below.

a. 90 % RH Max. ($T_a \leq 39 \text{ }^\circ\text{C}$)

b. Relative Humidity is 90% or less. ($T_a > 39 \text{ }^\circ\text{C}$)

c. No condensation

(3) 11ms, sine wave, one time for $\pm X$, $\pm Y$, $\pm Z$ axis

(4) 10-300 Hz, Sweep rate 10min, 30min for X,Y,Z axis

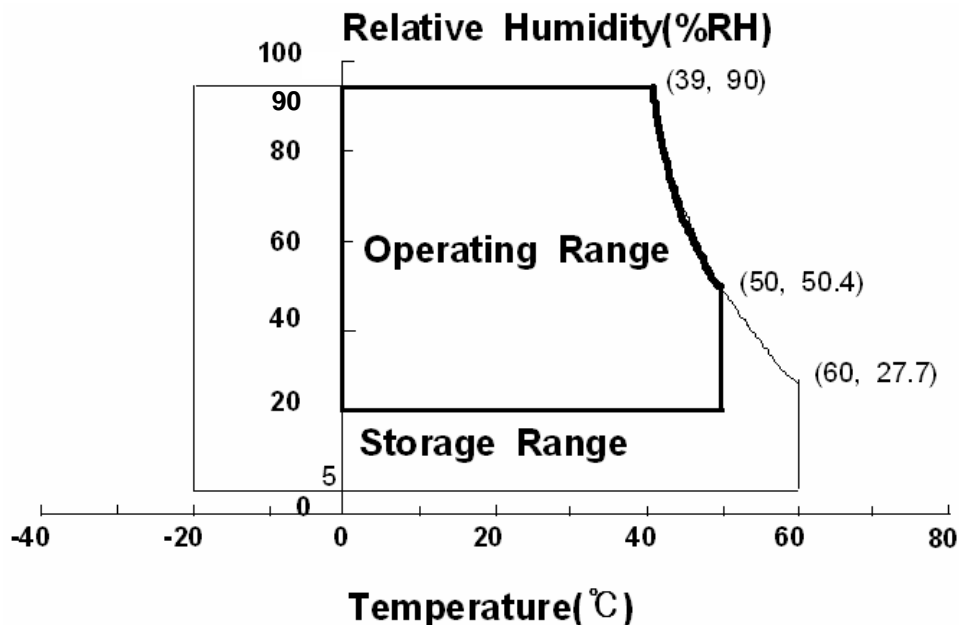
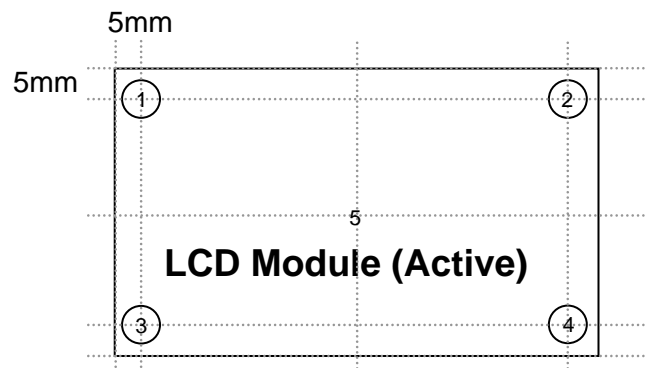

Fig. Temperature and Relative humidity range

(5) Definition of test point



T should be less than 10 ($T = |T_{\text{OPR}} - T_{\text{MAX}}|$)

T_{OPR} : Temperature of the center of the glass surface (Test point 5)

$T_1 \sim T_4$: Temperature of each edge of the glass surface

T_{MAX} : The highest temperature of the glass surface

2. Optical Characteristics

The optical characteristics should be measured in a dark room or equivalent.

Measuring equipment : TOPCON RD-80S, TOPCON SR-3, ELDIM EZ-Contrast

($T_a = 25 \pm 2^\circ\text{C}$, $V_{DD}=5\text{V}$, $f_v=60\text{Hz}$, $f_{DCLK}=75\text{MHz}$, $I_L = 8 \text{ mArms(Hot) / Duty } 100\%$)

| Item | Symbol | Condition | Min. | Typ. | Max. | Unit | Note | |
|--|-----------------|--|--------|---------------|---------------|---------------|-------------------|--------------------|
| Contrast Ratio (Center of screen) | C/R | Normal $\theta_{L,R}=0$ $\theta_{U,D}=0$ | 1,200 | 1,500 | - | | (1) SR-3 | |
| Response Time | G-to-G (Avg) | | Tg | - | 10 | 16 | | (3) RD-80S |
| Luminance of White (Center of screen) | Y_L | | | 400 | 450 | - | cd/m ² | (4) SR-3 |
| Color Chromaticity (CIE 1931) | Red | | Rx | Viewing Angle | TYP. -0.03 | TYP. +0.03 | | (5),(6) SR-3 |
| | | Ry | | | | | | |
| | Green | Gx | | | | | | |
| | | Gy | | | | | | |
| | Blue | Bx | | | | | | |
| | | By | | | | | | |
| | White | Wx | | | | | | |
| | | Wy | | | | | | |
| Color Gamut | - | | - | 72 | - | % | (5) SR-3 | |
| Color Temperature | - | | - | 10000 | - | K | (5) SR-3 | |
| Viewing Angle | Hor. | θ_L | C/R 10 | 75 | 89 | - | Degree | (6) EZ-Contrast |
| | | θ_R | | | | | | |
| | Ver. | θ_U | | | | | | |
| | | θ_D | | | | | | |
| Brightness Uniformity (9 Points) | B_{uni} | | - | - | 25 | % | (2) SR-3 | |

- Test Equipment Setup

The measurement should be executed in a stable, windless and dark room between 40min and 60min after lighting the back light at the given temperature for stabilization of the back light. This should be measured in the center of screen.

Inverter=62.5 (kHz \pm 2.5kHz, Dimming : Max)

Environment condition : $T_a = 25 \pm 2^\circ\text{C}$

MODEL

LTA320WT-L05

Doc. No

06-000-G-070227

Page

7 / 28

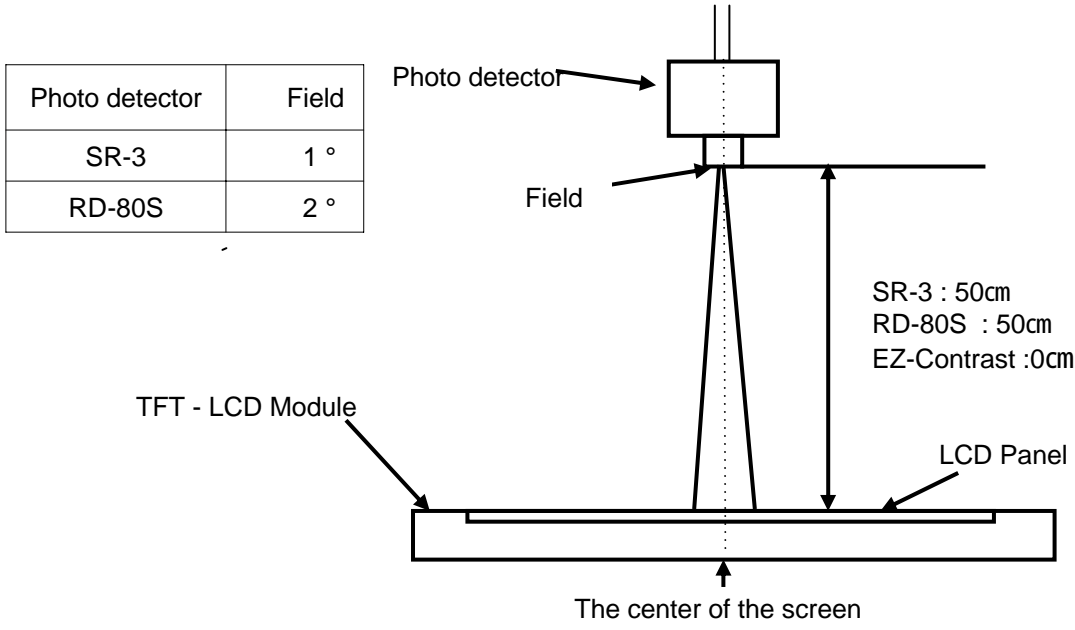

- Definition of test point

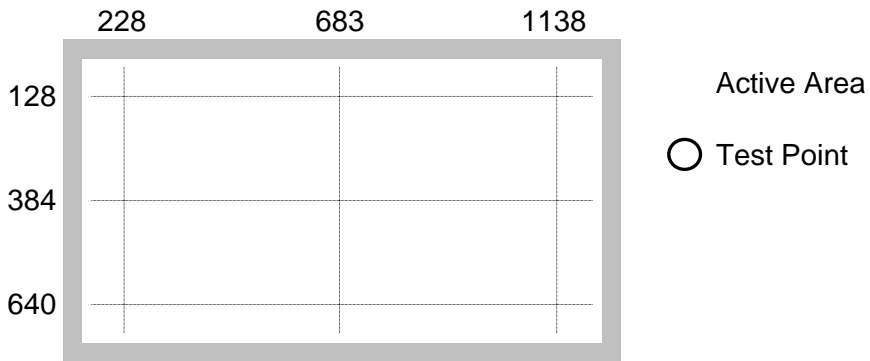

Note (1) Definition of Contrast Ratio (C/R)
 : Ratio of gray max (Gmax) & gray min (Gmin) at the center point of the panel

$$C/R = \frac{G_{max}}{G_{min}}$$

Gmax : Luminance with all pixels white
 Gmin : Luminance with all pixels black

| | | | | | |
|-------|--------------|---------|-----------------|------|--------|
| MODEL | LTA320WT-L05 | Doc. No | 06-000-G-070227 | Page | 8 / 28 |
|-------|--------------|---------|-----------------|------|--------|

Note (2) Definition of 9 points brightness uniformity (Test pattern : Full White)

$$B_{uni} = 100 * \frac{(B_{max} - B_{min})}{B_{max}}$$

Bmax : Maximum brightness
 Bmin : Minimum brightness

Note (3) Definition of Response time : Sum of Tr, Tf

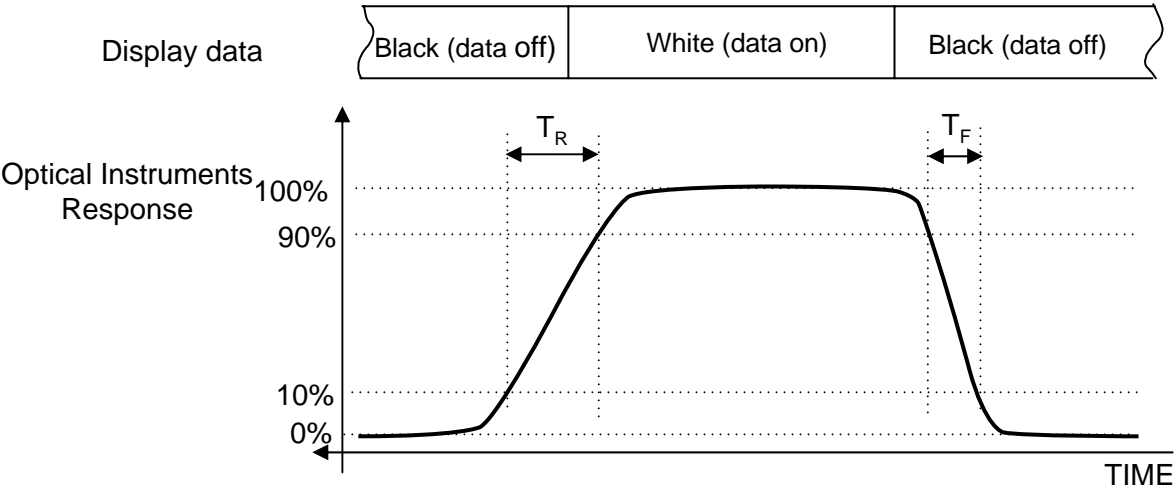

G-to-G : Average response time between Gray to gray (scale)

Note (4) Definition of Luminance of White : Luminance of white at center point

Note (5) Definition of Color Chromaticity (CIE 1931)
 Color coordinate of Red, Green, Blue & White at center point

Note (6) Definition of Viewing Angle
 : Viewing angle range (C/R 10)

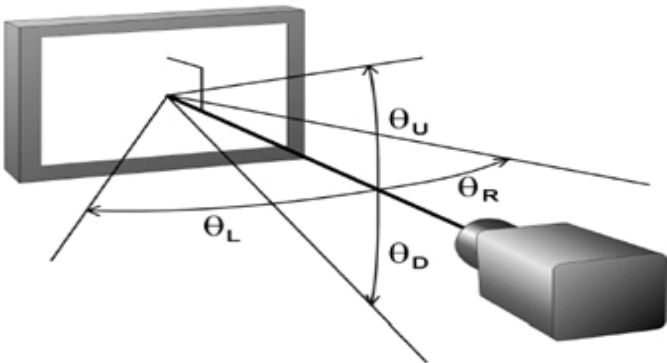

| | | | | | |
|-------|--------------|---------|-----------------|------|--------|
| MODEL | LTA320WT-L05 | Doc. No | 06-000-G-070227 | Page | 9 / 28 |
|-------|--------------|---------|-----------------|------|--------|

3. Electrical Characteristics

3.1 TFT LCD Module

The connector for display data & timing signal should be connected.

$$T_a = 25^{\circ}\text{C} \pm 2^{\circ}\text{C}$$

| Item | Symbol | Min. | Typ. | Max. | Unit | Note |
|-------------------------|---------------|------|------|------|------|---------|
| Voltage of Power Supply | V_{DD} | 4.5 | 5.0 | 5.5 | V | (1) |
| Current of Power Supply | (a) Black | - | 1000 | - | mA | (2),(3) |
| | (b) White | - | 1400 | - | mA | |
| | (c) N-Pattern | - | 1500 | 2200 | mA | |
| Vsync Frequency | f_V | 48 | 60 | 66 | Hz | |
| Hsync Frequency | f_H | 44 | 48 | 53 | kHz | |
| Main Frequency | f_{DCLK} | 65 | 75 | 82 | MHz | |
| Rush Current | I_{RUSH} | - | - | 4 | A | (4) |

Note (1) The ripple voltage should be controlled under 10% of V_{DD} .

(2) $f_V=60\text{Hz}$, $f_{DCLK} = 75\text{MHz}$, $V_{DD} = 5.0\text{V}$, DC Current.

(3) Power dissipation check pattern (LCD Module only)

a) Black Pattern

b) White Pattern

c) N-Pattern

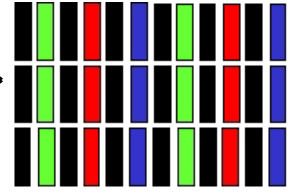
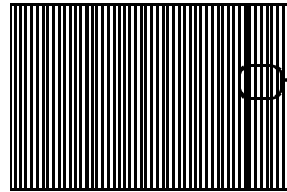

(4) Measurement Conditions

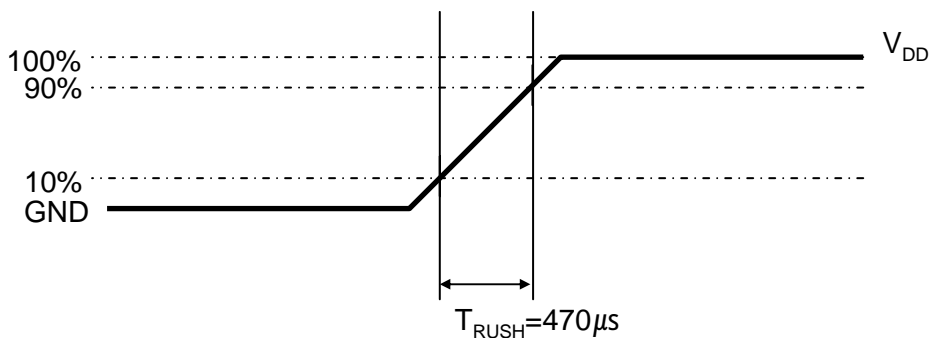

Rush Current I_{RUSH} can be measured when T_{RUSH} is $470\mu\text{s}$.

3.2 Back Light Unit

The back light unit contains 12 direct-lighting type CCFTs (Cold Cathode Fluorescent Tube). The characteristics of lamps are shown in the following tables.

$T_a = 25 \pm 2^\circ\text{C}$

| Item | Symbol | Min. | Typ. | Max. | Unit | Note |
|---------------------|--------|--------|------|------|-------|------|
| Lamp Current | I_L | 3.0 | 8.0 | 8.5 | mArms | |
| Lamp Voltage | V_L | - | 1200 | - | Vrms | |
| Operating Life Time | Hr | 50,000 | - | - | Hour | (1) |

Note (1) It is defined as the time to take until the brightness reduces to 50% of its original value.

[Operating condition : $T_a = 25 \pm 2$, $I_L = 8.0\text{mArms}$, For single lamp only.]

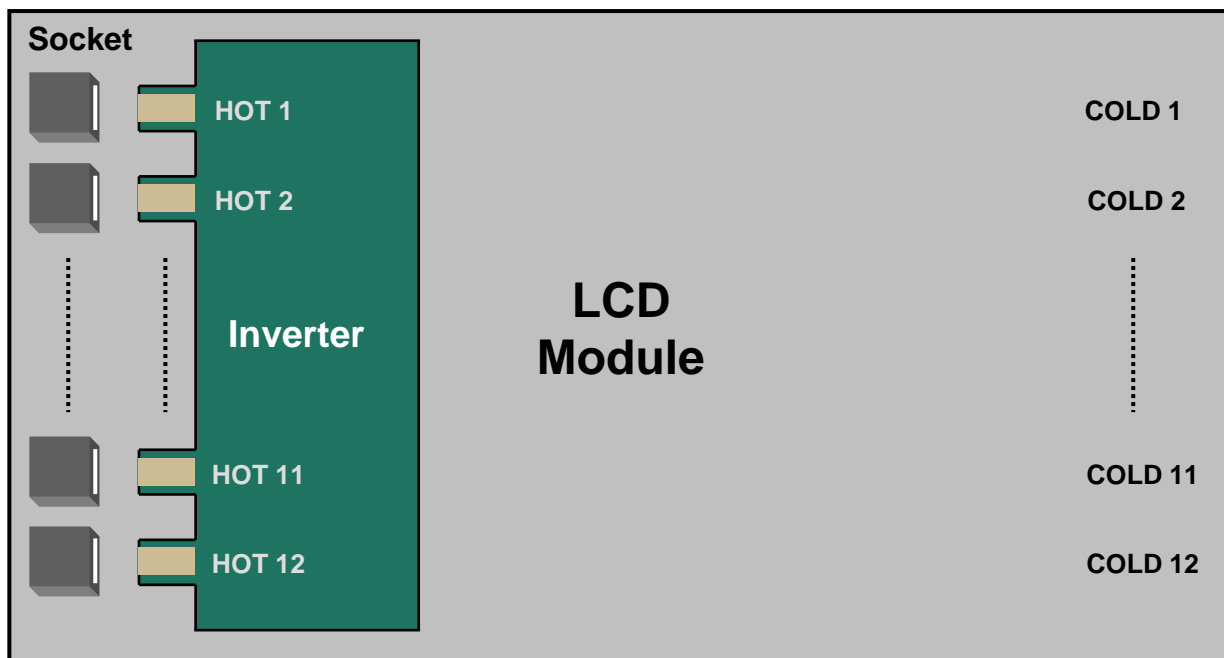

3.3 Inverter Input Condition & Specification

| Items | Symbol | Conditions | Specifications | | | Unit | Note |
|------------------|-------------------|--|----------------|------|------|-------|---|
| | | | Min. | Typ. | Max. | | |
| Input Voltage | V _{in} | - | 23 | 24 | 25 | V | T _a =25±2 °C |
| Input Current | I _{RUSH} | V _{in} =24.0V V _{dim} =3.3V | - | - | 5.5 | A | Initial Turn-on |
| Lamp Current | I _O | V _{dim} =3.3 V | 7.5 | 8.0 | 8.5 | mArms | After 2 Hours Warm-Up @V _{in} =24V |
| Frequency | F _{LAMP} | V _{in} =24.0 V | 60 | 62.5 | 65 | kHz | |
| Backlight On/Off | ON | V _{in} =24.0 V | 2.4 | - | 5.25 | V | - |
| | OFF | V _{in} =24.0 V | 0 | - | 0.8 | | |
| Dimming Control | V _{DIM} | Max Lum | 3.3 | - | - | V | - |
| | | Min. Lum | - | - | 0 | | |

4. Block Diagram

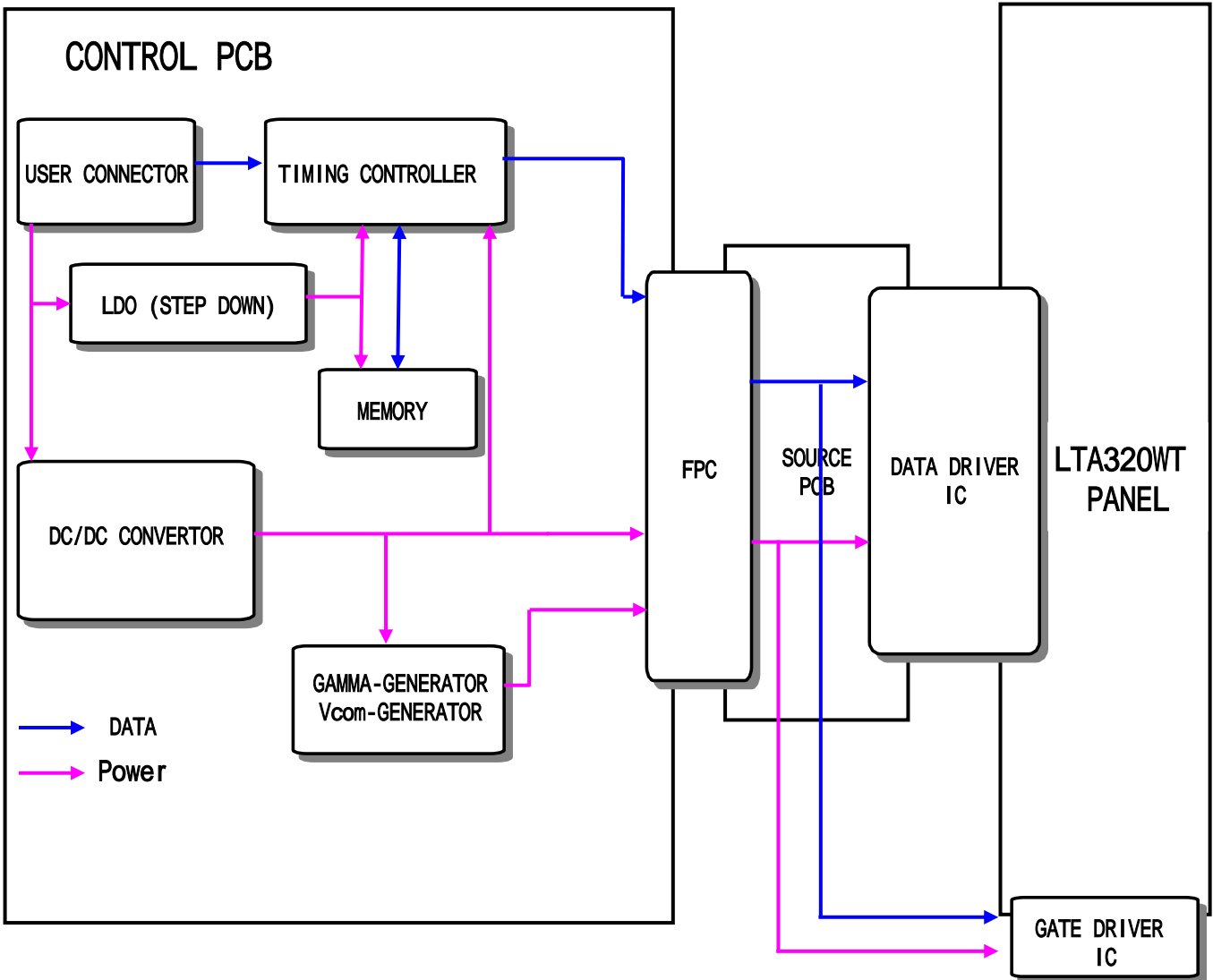

| | | | | | |
|-------|--------------|---------|-----------------|------|---------|
| MODEL | LTA320WT-L05 | Doc. No | 06-000-G-070227 | Page | 13 / 28 |
|-------|--------------|---------|-----------------|------|---------|

Note(1) Pin number starts from Right side

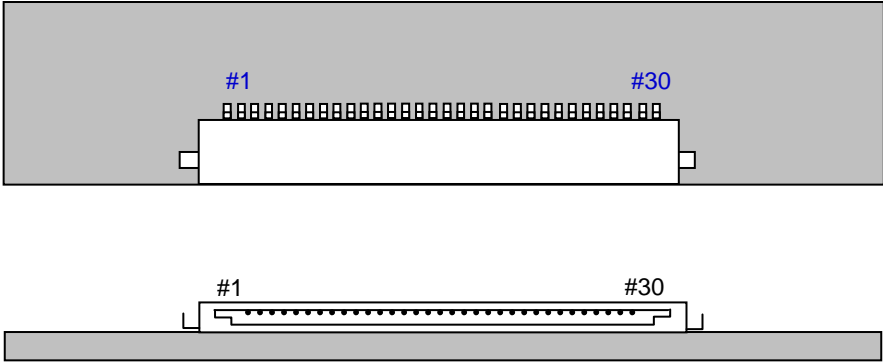
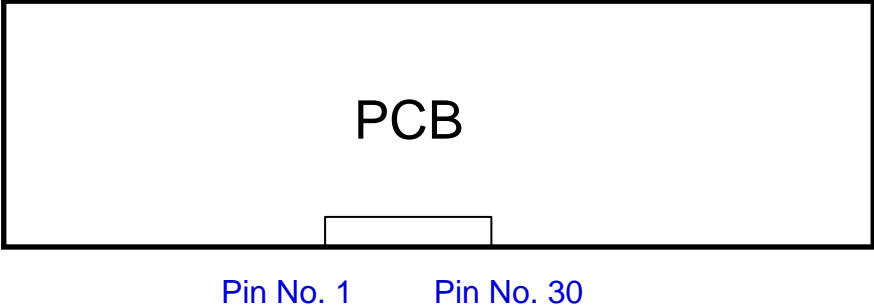

Fig. Connector diagram

- a. Power GND pins should be connected to the LCD's metal chassis.
- b. All power input pins should be connected together.
- c. All NC pin should be separated from other signal or power.

| | | | | | |
|-------|--------------|---------|-----------------|------|---------|
| MODEL | LTA320WT-L05 | Doc. No | 06-000-G-070227 | Page | 15 / 28 |
|-------|--------------|---------|-----------------|------|---------|

5.2. Inverter Input Pin Configuration

Connector : S14B-PHA-SM-TB(LF) (JST)

| Pin No. | Pin Configuration(FUNCTION) |
|---------|---|
| 1 | 24 V |
| 2 | 24 V |
| 3 | 24 V |
| 4 | 24 V |
| 5 | 24 V |
| 6 | GND |
| 7 | GND |
| 8 | GND |
| 9 | GND |
| 10 | GND |
| 11 | No Connection |
| 12 | Backlight On /Off [ON: 2.4 - 5 V, OFF: 0 - 0.8 V] |
| 13 | Dimming Control [0V: Min, 3.3V: Max] |
| 14 | No Connection |

5.3. Inverter Input Power Sequence

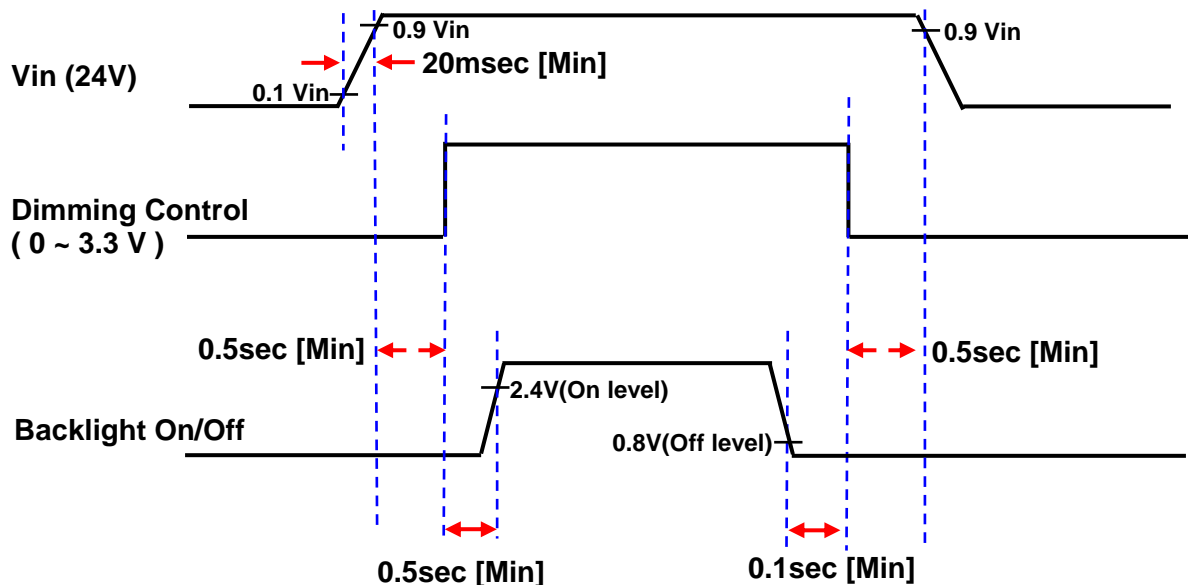

5.4 LVDS Interface

- LVDS Receiver : Tcon (merged)
- Data Format (JEIDA & Normal)

| | LVDS pin | JEIDA -DATA | VESA -DATA |
|-------------|--------------|-------------|------------|
| TxOUT/RxIN0 | TxIN/RxOUT0 | R2 | R0 |
| | TxIN/RxOUT1 | R3 | R1 |
| | TxIN/RxOUT2 | R4 | R2 |
| | TxIN/RxOUT3 | R5 | R3 |
| | TxIN/RxOUT4 | R6 | R4 |
| | TxIN/RxOUT6 | R7 | R5 |
| | TxIN/RxOUT7 | G2 | G0 |
| TxOUT/RxIN1 | TxIN/RxOUT8 | G3 | G1 |
| | TxIN/RxOUT9 | G4 | G2 |
| | TxIN/RxOUT12 | G5 | G3 |
| | TxIN/RxOUT13 | G6 | G4 |
| | TxIN/RxOUT14 | G7 | G5 |
| | TxIN/RxOUT15 | B2 | B0 |
| | TxIN/RxOUT18 | B3 | B1 |
| TxOUT/RxIN2 | TxIN/RxOUT19 | B4 | B2 |
| | TxIN/RxOUT20 | B5 | B3 |
| | TxIN/RxOUT21 | B6 | B4 |
| | TxIN/RxOUT22 | B7 | B5 |
| | TxIN/RxOUT24 | HSYNC | HSYNC |
| | TxIN/RxOUT25 | VSYNC | VSYNC |
| | TxIN/RxOUT26 | DEN | DEN |
| TxOUT/RxIN3 | TxIN/RxOUT27 | R0 | R6 |
| | TxIN/RxOUT5 | R1 | R7 |
| | TxIN/RxOUT10 | G0 | G6 |
| | TxIN/RxOUT11 | G1 | G7 |
| | TxIN/RxOUT16 | B0 | B6 |
| | TxIN/RxOUT17 | B1 | B7 |
| | TxIN/RxOUT23 | RESERVED | RESERVED |

5.5 Input Signals, Basic Display Colors and Gray Scale of Each Color

| COLOR | DISPLAY (8bit) | DATA SIGNAL | | | | | | | | | | | | | | | | | | | | | | | | GRAY SCALE LEVEL |
|---------------------|----------------|-------------|----|----|----|----|----|----|-------|----|----|----|----|----|----|------|----|----|----|----|----|----|----|----|---------|------------------|
| | | RED | | | | | | | GREEN | | | | | | | BLUE | | | | | | | | | | |
| | | R0 | R1 | R2 | R3 | R4 | R5 | R6 | R7 | G0 | G1 | G2 | G3 | G4 | G5 | G6 | G7 | B0 | B1 | B2 | B3 | B4 | B5 | B6 | B7 | |
| BASIC COLOR | BLACK | 0 | 0 | 0 | 0 | 0 | 0 | 0 | 0 | 0 | 0 | 0 | 0 | 0 | 0 | 0 | 0 | 0 | 0 | 0 | 0 | 0 | 0 | 0 | 0 | - |
| | BLUE | 0 | 0 | 0 | 0 | 0 | 0 | 0 | 0 | 0 | 0 | 0 | 0 | 0 | 0 | 0 | 0 | 1 | 1 | 1 | 1 | 1 | 1 | 1 | 1 | - |
| | GREEN | 0 | 0 | 0 | 0 | 0 | 0 | 0 | 0 | 1 | 1 | 1 | 1 | 1 | 1 | 1 | 1 | 0 | 0 | 0 | 0 | 0 | 0 | 0 | 0 | - |
| | CYAN | 0 | 0 | 0 | 0 | 0 | 0 | 0 | 0 | 1 | 1 | 1 | 1 | 1 | 1 | 1 | 1 | 1 | 1 | 1 | 1 | 1 | 1 | 1 | 1 | - |
| | RED | 1 | 1 | 1 | 1 | 1 | 1 | 1 | 1 | 0 | 0 | 0 | 0 | 0 | 0 | 0 | 0 | 0 | 0 | 0 | 0 | 0 | 0 | 0 | 0 | - |
| | MAGENTA | 1 | 1 | 1 | 1 | 1 | 1 | 1 | 1 | 0 | 0 | 0 | 0 | 0 | 0 | 0 | 0 | 1 | 1 | 1 | 1 | 1 | 1 | 1 | 1 | - |
| | YELLOW | 1 | 1 | 1 | 1 | 1 | 1 | 1 | 1 | 1 | 1 | 1 | 1 | 1 | 1 | 1 | 1 | 0 | 0 | 0 | 0 | 0 | 0 | 0 | 0 | - |
| | WHITE | 1 | 1 | 1 | 1 | 1 | 1 | 1 | 1 | 1 | 1 | 1 | 1 | 1 | 1 | 1 | 1 | 1 | 1 | 1 | 1 | 1 | 1 | 1 | 1 | - |
| GRAY SCALE OF RED | BLACK | 0 | 0 | 0 | 0 | 0 | 0 | 0 | 0 | 0 | 0 | 0 | 0 | 0 | 0 | 0 | 0 | 0 | 0 | 0 | 0 | 0 | 0 | 0 | R0 | |
| | DARK | 1 | 0 | 0 | 0 | 0 | 0 | 0 | 0 | 0 | 0 | 0 | 0 | 0 | 0 | 0 | 0 | 0 | 0 | 0 | 0 | 0 | 0 | 0 | R1 | |
| | | 0 | 1 | 0 | 0 | 0 | 0 | 0 | 0 | 0 | 0 | 0 | 0 | 0 | 0 | 0 | 0 | 0 | 0 | 0 | 0 | 0 | 0 | 0 | R2 | |
| | | : | : | : | : | : | : | : | : | : | : | : | : | : | : | : | : | : | : | : | : | : | : | : | R3~R252 | |
| | | : | : | : | : | : | : | : | : | : | : | : | : | : | : | : | : | : | : | : | : | : | : | : | | |
| | LIGHT | 1 | 0 | 1 | 1 | 1 | 1 | 1 | 1 | 0 | 0 | 0 | 0 | 0 | 0 | 0 | 0 | 0 | 0 | 0 | 0 | 0 | 0 | 0 | R253 | |
| | | 0 | 1 | 1 | 1 | 1 | 1 | 1 | 1 | 0 | 0 | 0 | 0 | 0 | 0 | 0 | 0 | 0 | 0 | 0 | 0 | 0 | 0 | 0 | R254 | |
| | RED | 1 | 1 | 1 | 1 | 1 | 1 | 1 | 1 | 0 | 0 | 0 | 0 | 0 | 0 | 0 | 0 | 0 | 0 | 0 | 0 | 0 | 0 | 0 | R255 | |
| GRAY SCALE OF GREEN | BLACK | 0 | 0 | 0 | 0 | 0 | 0 | 0 | 0 | 0 | 0 | 0 | 0 | 0 | 0 | 0 | 0 | 0 | 0 | 0 | 0 | 0 | 0 | 0 | G0 | |
| | DARK | 0 | 0 | 0 | 0 | 0 | 0 | 0 | 0 | 1 | 0 | 0 | 0 | 0 | 0 | 0 | 0 | 0 | 0 | 0 | 0 | 0 | 0 | 0 | G1 | |
| | | 0 | 0 | 0 | 0 | 0 | 0 | 0 | 0 | 0 | 1 | 0 | 0 | 0 | 0 | 0 | 0 | 0 | 0 | 0 | 0 | 0 | 0 | 0 | G2 | |
| | | : | : | : | : | : | : | : | : | : | : | : | : | : | : | : | : | : | : | : | : | : | : | : | G3~G252 | |
| | | : | : | : | : | : | : | : | : | : | : | : | : | : | : | : | : | : | : | : | : | : | : | : | | |
| | LIGHT | 0 | 0 | 0 | 0 | 0 | 0 | 0 | 0 | 1 | 0 | 1 | 1 | 1 | 1 | 1 | 1 | 0 | 0 | 0 | 0 | 0 | 0 | 0 | G253 | |
| | | 0 | 0 | 0 | 0 | 0 | 0 | 0 | 0 | 0 | 1 | 1 | 1 | 1 | 1 | 1 | 1 | 0 | 0 | 0 | 0 | 0 | 0 | 0 | G254 | |
| | GREEN | 0 | 0 | 0 | 0 | 0 | 0 | 0 | 0 | 1 | 1 | 1 | 1 | 1 | 1 | 1 | 1 | 0 | 0 | 0 | 0 | 0 | 0 | 0 | G255 | |
| GRAY SCALE OF BLUE | BLACK | 0 | 0 | 0 | 0 | 0 | 0 | 0 | 0 | 0 | 0 | 0 | 0 | 0 | 0 | 0 | 0 | 0 | 0 | 0 | 0 | 0 | 0 | 0 | B0 | |
| | DARK | 0 | 0 | 0 | 0 | 0 | 0 | 0 | 0 | 0 | 0 | 0 | 0 | 0 | 0 | 0 | 0 | 1 | 0 | 0 | 0 | 0 | 0 | 0 | B1 | |
| | | 0 | 0 | 0 | 0 | 0 | 0 | 0 | 0 | 0 | 0 | 0 | 0 | 0 | 0 | 0 | 0 | 0 | 1 | 0 | 0 | 0 | 0 | 0 | B2 | |
| | | : | : | : | : | : | : | : | : | : | : | : | : | : | : | : | : | : | : | : | : | : | : | : | B3~B252 | |
| | | : | : | : | : | : | : | : | : | : | : | : | : | : | : | : | : | : | : | : | : | : | : | : | | |
| | LIGHT | 0 | 0 | 0 | 0 | 0 | 0 | 0 | 0 | 0 | 0 | 0 | 0 | 0 | 0 | 0 | 0 | 1 | 0 | 1 | 1 | 1 | 1 | 1 | B253 | |
| | | 0 | 0 | 0 | 0 | 0 | 0 | 0 | 0 | 0 | 0 | 0 | 0 | 0 | 0 | 0 | 0 | 0 | 1 | 1 | 1 | 1 | 1 | 1 | B254 | |
| | BLUE | 0 | 0 | 0 | 0 | 0 | 0 | 0 | 0 | 0 | 0 | 0 | 0 | 0 | 0 | 0 | 0 | 1 | 1 | 1 | 1 | 1 | 1 | 1 | B255 | |

Note) Definition of Gray :
 Rn : Red Gray, Gn : Green Gray, Bn : Blue Gray (n = Gray level)
 Input Signal : 0 = Low level voltage, 1 = High level voltage

6. Interface Timing

6.1 Timing Parameters (DE only mode)

| SIGNAL | ITEM | SYMBOL | MIN. | TYP. | MAX. | Unit | NOTE |
|-------------------------|-----------------------|----------|------|------|------|--------|------|
| Clock | Frequency | $1/T_C$ | 65 | 75 | 82 | MHz | - |
| Hsync | | F_H | 44 | 48 | 53 | KHz | - |
| Vsync | | F_V | 48 | 60 | 66 | Hz | - |
| Vertical Display Term | Active Display Period | T_{VD} | - | 768 | - | lines | - |
| | Vertical Total | T_V | 773 | 838 | 1200 | lines | - |
| Horizontal Display Term | Active Display Period | T_{HD} | - | 1366 | - | clocks | - |
| | Horizontal Total | T_H | 1460 | 1600 | 2000 | clocks | - |

Note) This product is DE only mode. The input of Hsync & Vsync signal does not have an effect on normal operation.

- (1) Test Point : TTL control signal and CLK at LVDS Tx input terminal in system
- (2) Internal $V_{DD} = 3.3V$

6.2 Timing diagrams of interface signal (DE only mode)

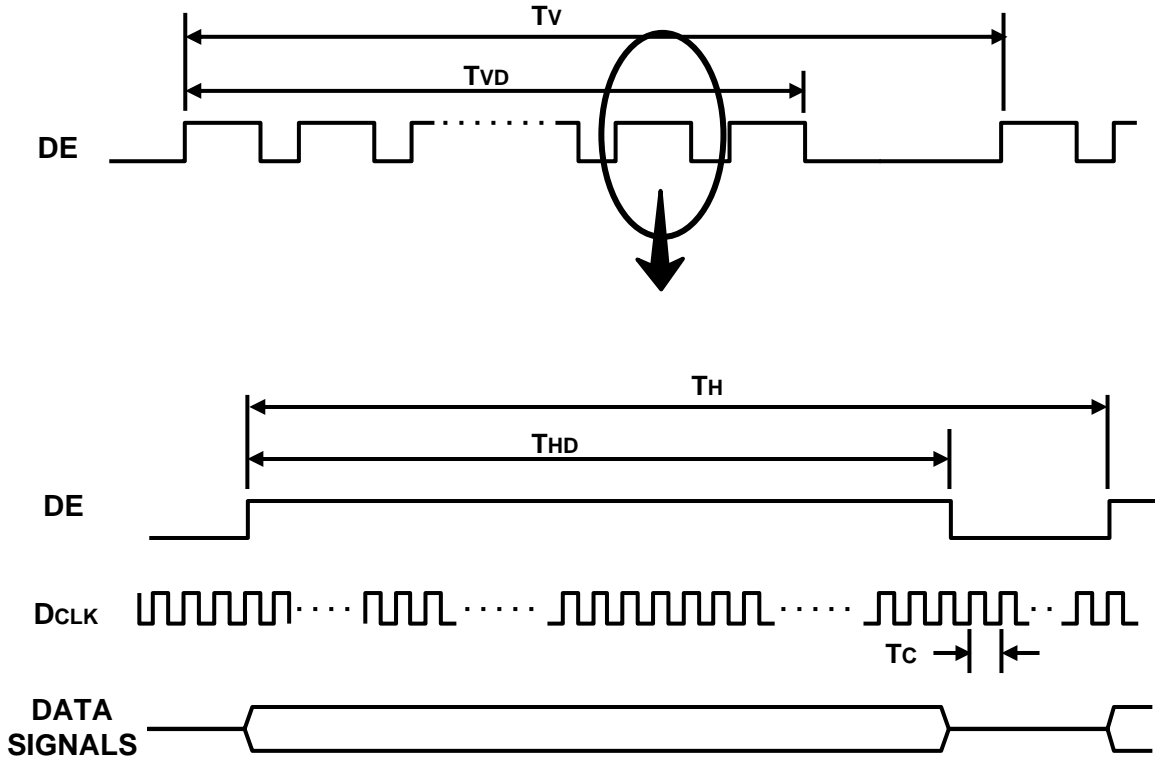

6.3 Power ON/OFF Sequence

To prevent a latch-up or DC operation of the LCD Module, the power on/off sequence should be as the diagram below.

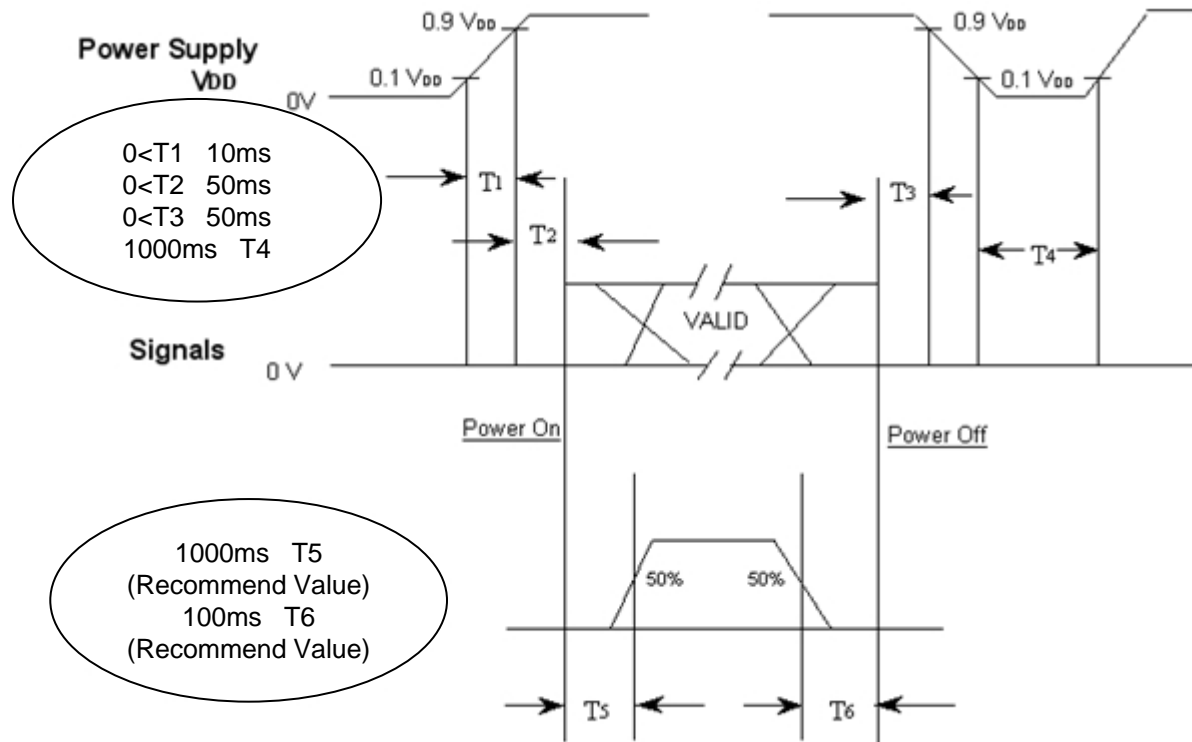

- $T1$: V_{DD} rising time from 10% to 90%
- $T2$: The time from V_{DD} to valid data at power ON.
- $T3$: The time from valid data off to V_{DD} off at power Off.
- $T4$: V_{DD} off time for Windows restart
- $T5$: The time from valid data to B/L enable at power ON.
- $T6$: The time from valid data off to B/L disable at power Off.

- The supply voltage of the external system for the Module input should be the same as the definition of V_{DD} .
- Apply the lamp voltage within the LCD operation range. When the back light turns on before the LCD operation or the LCD turns off before the back light turns off, the display may momentarily show abnormal screen.
- In case of V_{DD} = off level, please keep the level of input signals low or keep a high impedance.
- $T4$ should be measured after the Module has been fully discharged between power off and on period.
- Interface signal should not be kept at high impedance when the power is on.

7. Outline Dimension (Rear View)

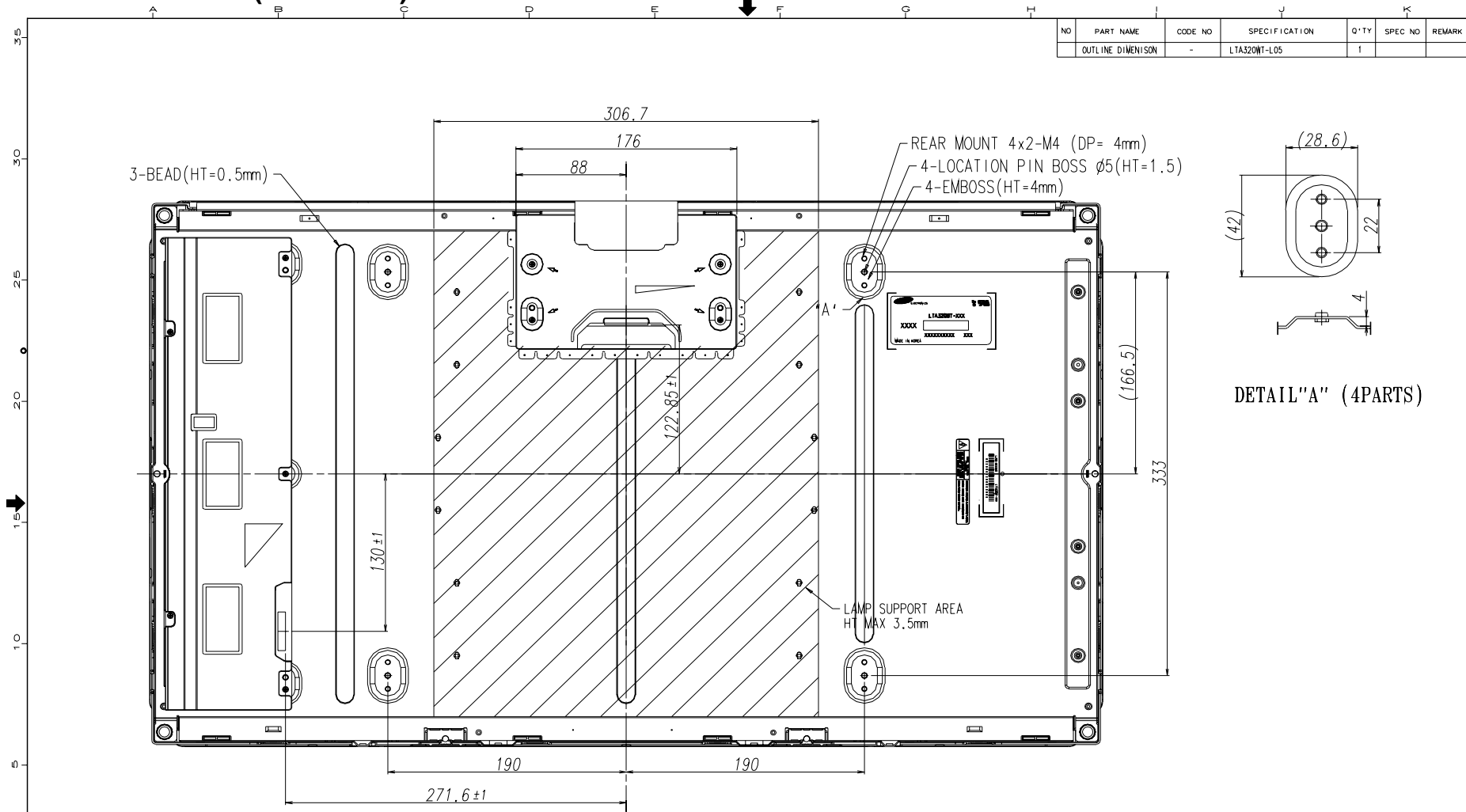

| NO | PART NAME | CODE NO | SPECIFICATION | Q'TY | SPEC NO | REMARK |
|----|-------------------|---------|---------------|------|---------|--------|
| | OUTLINE DIMENSION | - | LTA320WT-L05 | 1 | | |

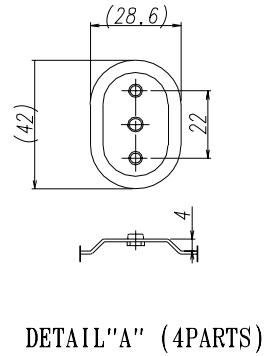

PRELIMINARY

| GENERAL TOLERANCE | | | | REV | DATE | DESCRIPTION OF REVISION | | | REASON | | CHG'D BY |
|-------------------|---------|---------|---------|---------------------|------|-------------------------|-----------|----------|----------|-----------------|--------------------|
| STEP | LEVEL 1 | LEVEL 2 | LEVEL 3 | UNIT | mm | DRA'N BY | DES'D BY | CHK'D BY | APP'D BY | MODEL NAME | LTA320WT-L05 |
| 0 < X ≤ 4 | ±0.05 | ±0.1 | ±0.2 | SCALE | 1/2 | | | | J.H.CHUN | PART/SHEET NAME | OUTLINE DIM.(REAR) |
| 4 < X ≤ 16 | ±0.08 | ±0.15 | ±0.3 | TOLERANCE | | | | 07.02.01 | 07.02.02 | | SHEET 2/2 |
| 16 < X ≤ 64 | ±0.12 | ±0.25 | ±0.5 | SAMSUNG ELECTRONICS | | | SPEC. NO. | | | CODE NO. | |
| 64 < X ≤ 256 | ±0.25 | ±0.4 | ±0.8 | | | | | | | VER | 000 |

8. PACKING

8.1 CARTON (Internal Package)

(1) Packing Form

Corrugated fiberboard box and corrugated cardboard as shock absorber

(2) Packing Method

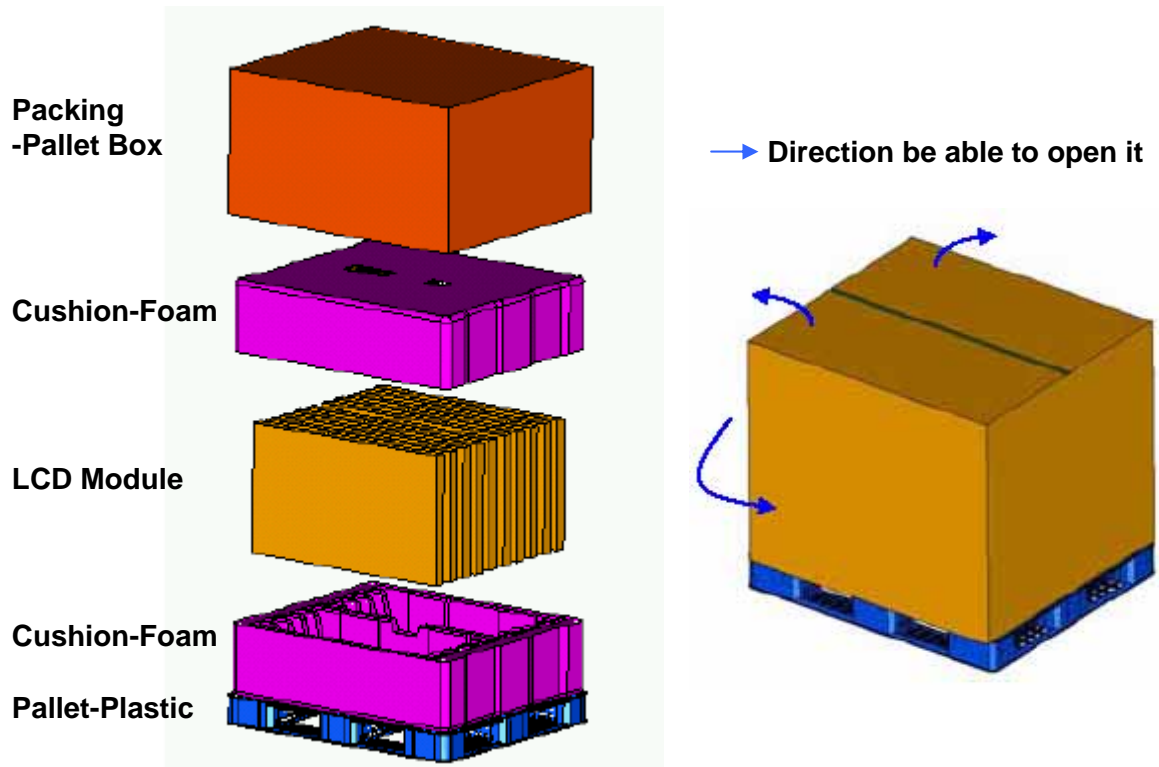

8.2 Packing Specification

| Item | Specification | Remark |
|---------------------|-----------------------------|---|
| LCD Packing | 24ea / (Packing-Pallet Box) | 1. 168 Kg / LCD (24ea) 2. 14 Kg / Cushion-pallet (4ea) 3. 8.8 Kg / Packing-Pallet Box (1ea) 4. Cushion-pallet Material : EPS 5. Packing-Pallet Box Material : DW4 |
| Pallet | 1Box / Pallet | 1. Pallet weight = 8kg 2. 8Kg/Pallet |
| Packing Direction | Vertical | |
| Total Pallet Size | H x V x height | 1150mm(H) x 985mm(V) x 634mm(height) |
| Total Pallet Weight | 198.8 kg | Pallet(8kg) + Module(7*24=168) + Cushion(4ea=14kg) + Pallet-BOX(8.8kg) |

MODEL

LTA320WT-L05

Doc. No

06-000-G-070227

Page

24 / 28

9. MARKING & OTHERS

A nameplate bearing followed by is affixed to a shipped product at the specified location on each product.

- (1) Parts number : LTA320WT-L05
- (2) Revision: Three letters
- (3) Lot number : X X X X XXX XX X

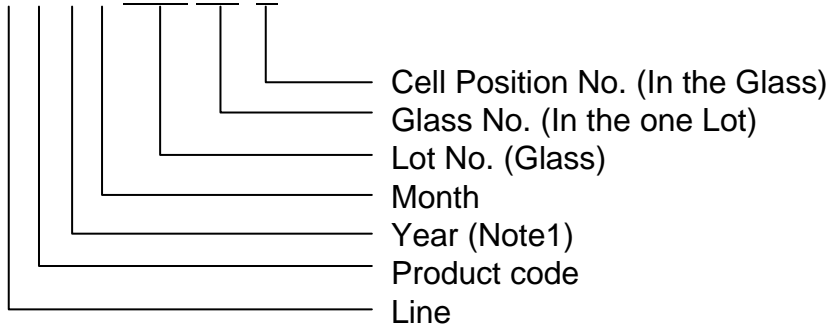

(4) Nameplate Indication

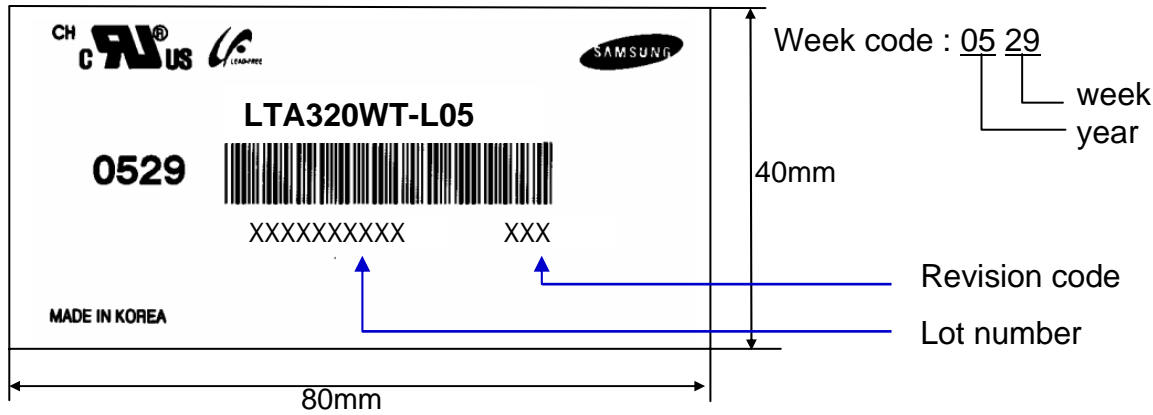

(5) Packing box attach

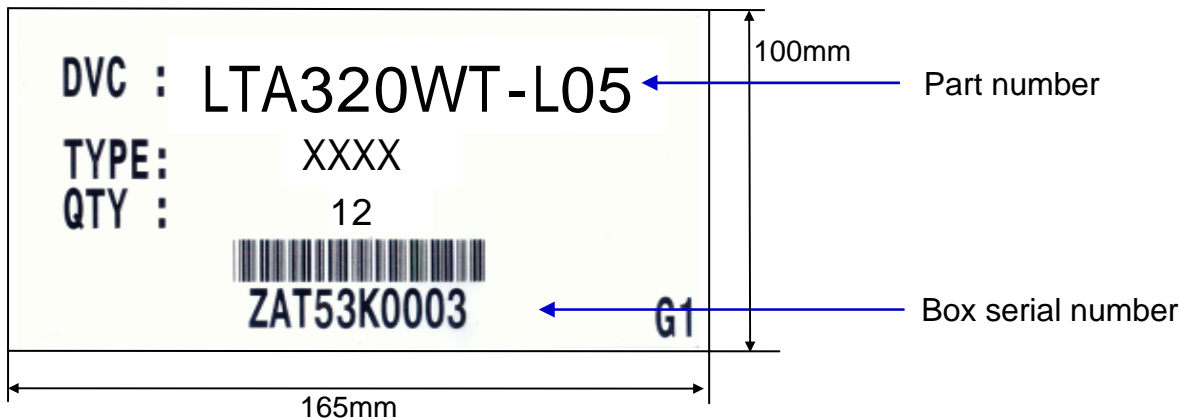

(6) Others

- 1. After service part
 Lamps cannot be replaced because of the narrow bezel structure.

| | | | | | |
|-------|--------------|---------|-----------------|------|---------|
| MODEL | LTA320WT-L05 | Doc. No | 06-000-G-070227 | Page | 25 / 28 |
|-------|--------------|---------|-----------------|------|---------|

10. General Precautions

10.1 Handling

- (a) When the Module is assembled, it should be attached to the system firmly using all mounting holes. Be careful not to twist and bend the Module.
- (b) Because the inverter use high voltage, it should be disconnected from power before it is assembled or disassembled.
- (c) Refrain from strong mechanical shock and / or any force to the Module.
In addition to damage, this may cause improper operation or damage to the Module and CCFL back light.
- (d) Note that polarizers are very fragile and could be damage easily.
Do not press or scratch the surface harder than a HB pencil lead.
- (e) Wipe off water droplets or oil immediately. If you leave the droplets for a long time, staining or discoloration may occur.
- (f) If the surface of the polarizer is dirty, clean it using absorbent cotton or soft cloth.
- (g) Desirable cleaners are water, IPA(Isopropyl Alcohol) or Hexane.
Do not use Ketone type materials(ex. Acetone), Ethyl alcohol, Toluene, Ethyl acid or Methyl chloride. It might permanent damage to the polarizer due to chemical reaction.
- (h) If the liquid crystal material leaks from the panel, it should be kept away from the eyes or mouth . In case of contact with hands, legs or clothes, it must be washed away with soap thoroughly.
- (i) Protect the module from Electrostatic discharge. Otherwise the ASIC IC or Semiconductor would be damaged.
- (j) Use finger-stalls with soft gloves in order to keep display clean during the incoming inspection and assembly process.
- (k) Do not disassemble the Module.
- (l) Do not disassemble shield case of inverter & LVDS board.
- (m) Do not connect N.C pins. (Samsung internal use only)
- (n) Protection film for polarizer on the Module should be slowly peeled off just before use so that the electrostatic charge can be minimized. Must put on antistatic glove while handle a module
- (o) Pins of I/F connector should not be touched directly with bare hands.

10.2 Storage

- (a) Do not leave the Module in high temperature, and high humidity for a long time. It is highly recommended to store the Module with temperature from 0 to 35 and relative humidity of less than 70%.
- (b) Do not store the TFT-LCD Module in direct sunlight.
- (c) The Module should be stored in a dark place. It is prohibited to apply sunlight or fluorescent light in storing.

10.3 Operation

- (a) Do not connect or disconnect the Module in the "Power On" condition.
- (b) Power supply should always be turned on/off by the "Power on/off sequence"
- (c) Module has high frequency circuits. Sufficient suppression to the electromagnetic interference should be done by system manufacturers. Grounding and shielding methods may be important to minimize the interference.
- (d) The cable between the back light connector and its inverter power supply should be connected directly with a minimized length. A longer cable between the back light and the inverter may cause lower luminance of lamp(CCFT) and may require higher startup voltage(Vs).

10.4 Operation Condition Guide

- (a) The LCD product should be operated under normal conditions.
Normal condition is defined as below;
 - Temperature : 20 ± 15
 - Humidity : $55 \pm 20\%$
 - Display pattern : continually changing pattern (Not stationary)
- (b) If the product will be used in extreme conditions such as high temperature, humidity, display patterns or operation time etc., It is strongly recommended to contact SEC for Application engineering advice. Otherwise, its reliability and function may not be guaranteed. Extreme conditions are commonly found at Airports, Transit Stations, Banks, Stock market, and Controlling systems.

| | | | | | |
|-------|--------------|---------|-----------------|------|---------|
| MODEL | LTA320WT-L05 | Doc. No | 06-000-G-070227 | Page | 27 / 28 |
|-------|--------------|---------|-----------------|------|---------|

10.5 Others

- (a) Ultra-violet ray filter is necessary for outdoor operation.
- (b) Avoid condensation of water. It may result in improper operation or disconnection of electrode.
- (c) Do not exceed the absolute maximum rating value. (supply voltage variation, input voltage variation, variation in part contents and environmental temperature, and so on)
Otherwise the Module may be damaged.
- (d) If the Module keeps displaying the same pattern for a long period of time, the image may be "sticked" to the screen.
To avoid image sticking, it is recommended to use a screen saver.
- (e) This Module has its circuitry PCB's on the rear side and should be handled carefully in order not to be stressed.
- (f) Please contact SEC in advance when you display the same pattern for a long time.

| | | | | | |
|-------|--------------|---------|-----------------|------|---------|
| MODEL | LTA320WT-L05 | Doc. No | 06-000-G-070227 | Page | 28 / 28 |
|-------|--------------|---------|-----------------|------|---------|